

Führungsschienen bis 1500 mm

Longueur de la coulisse jusqu'à 1500mm

Lunghezza della guida fino a 1500 mm

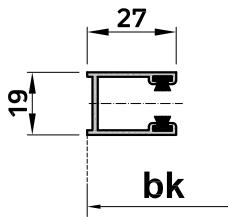

Führungsschiene normal  
Coulisse normale  
Guida normale

NO

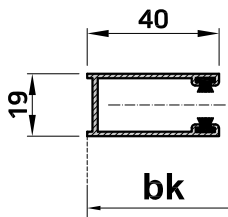

Verstärkte Führung  
Coulisse renforcé  
Guida rinforzata

BR

bk > 3200mm

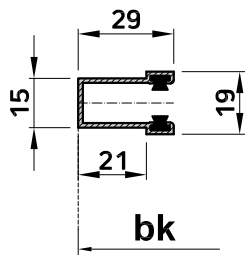

Führungsschiene zum  
Einlassen  
Coulisse à emboîter  
Guida da incasso

EF

Lager Standard

Support standard

Supporto Standard

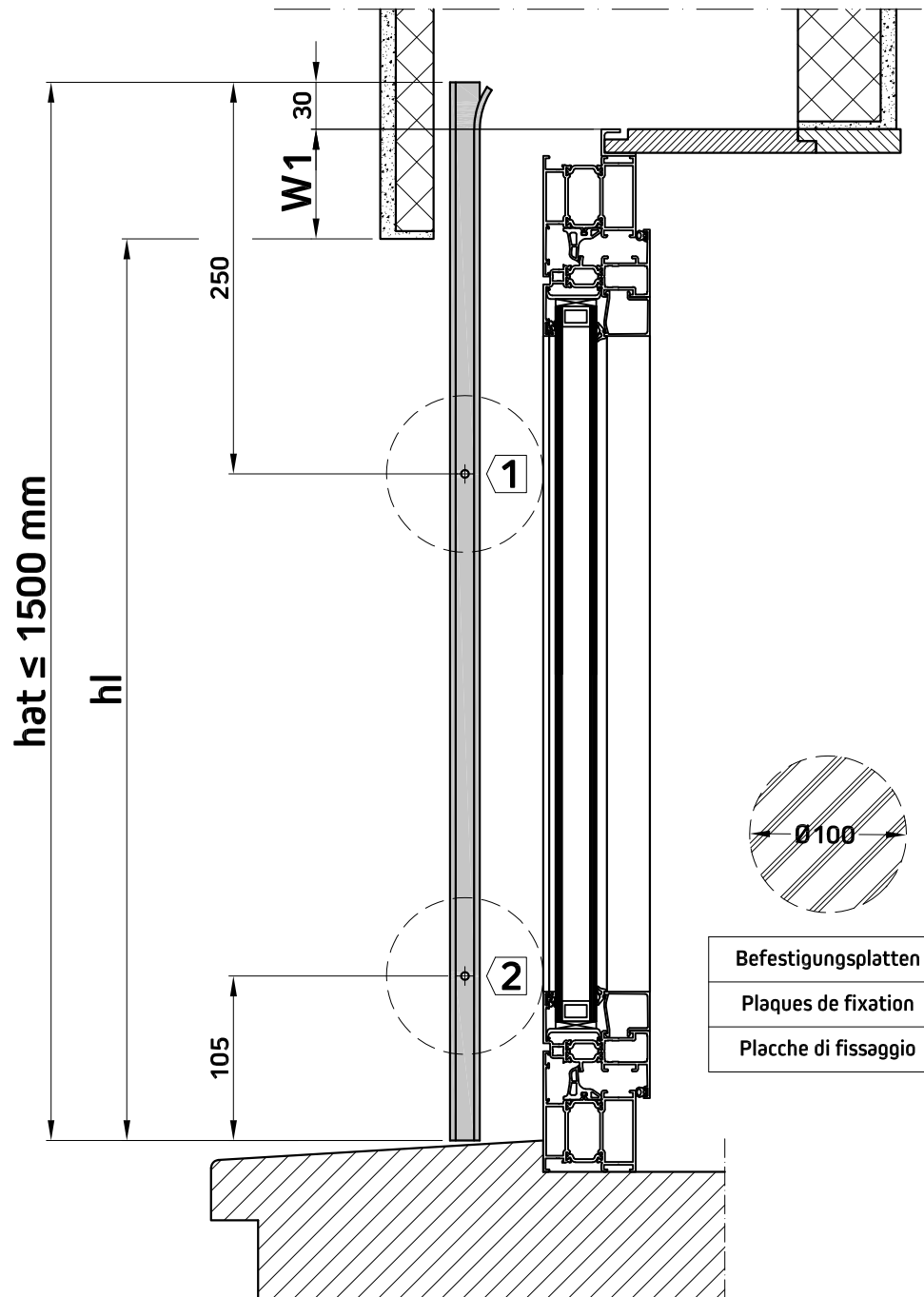

Befestigungsplatten

Plaques de fixation

Placche di fissaggio

hat	Führungsschienehöhe (Länge)	Longueur de la coulisse	Lunghezza della guida
hl	Fensterlichhöhe	Hauteur lumière	Altezza luce finestra
w1	Führungsverlängerung	Prolongement de la coulisse	Prolungamento della guida
bk	Breite Konstruktion	Largeur lumière	Larghezza luce finestra

Regaroll®

DOC. CODE: 2DW-200057-V00

Das Komfort Rollladensystem  
Le système de volet roulant confort  
Il sistema di avvolgibile comfort

Lochtabelle standard  
Perforation de la coulisse standard  
Foratura guide standard

Technische Daten  
Données techniques  
Dati tecnici

 **Regazzi**

[www.madeinregazzi.ch](http://www.madeinregazzi.ch)

Führungsschienen von 1501 bis 2500 mm

Longueur de la coulisse entre 1501 et 2500 mm

Lunghezza della guida tra 1501 e 2500 mm

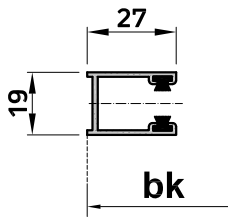

Führungsschiene normal  
Coulisse normale  
Guida normale

NO

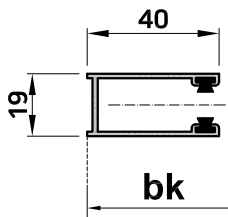

Verstärkte Führung  
Coulisse renforcé  
Guida rinforzata

BR

bk > 3200mm

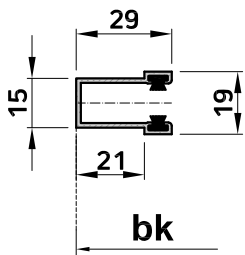

Führungsschiene zum  
Einlassen  
Coulisse à emboîter  
Guida da incasso

EF

Lager Standard

Support standard

Supporto Standard

1501 ≤ hat ≤ 2500 mm

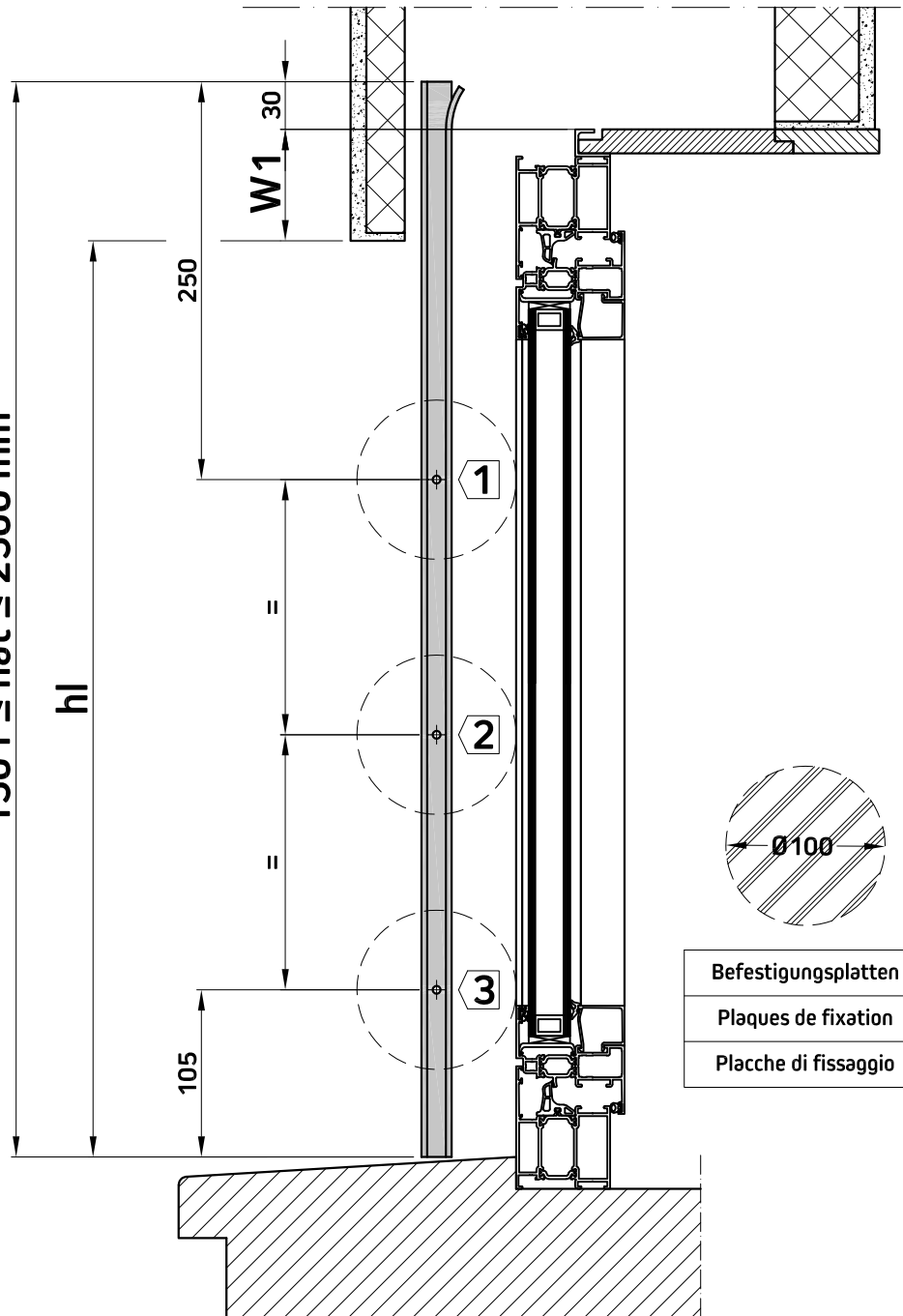

Befestigungslatten

Plaques de fixation

Placche di fissaggio

hat	Führungsschienehöhe (Länge)	Longueur de la coulisse	Lunghezza della guida
hl	Fensterlichhöhe	Hauteur lumière	Altezza luce finestra
w1	Führungsverlängerung	Prolongement de la coulisse	Prolungamento della guida
bk	Breite Konstruktion	Largeur lumière	Larghezza luce finestra

Regaroll®

DOC. CODE: 2DW-200058-V00

Das Komfort Rollladensystem  
Le système de volet roulant confort  
Il sistema di avvolgibile confort

Lochtabelle standard  
Perforation de la coulisse standard  
Foratura guide standard

Technische Daten  
Données techniques  
Dati tecnici

 **Regazzi**

[www.madeinregazzi.ch](http://www.madeinregazzi.ch)

Führungsschienen über 2500 mm

Longueur de la coulisse supérieur à 2500mm

Lunghezza della guida superiore a 2500 mm

Lager Standard

Support standard

Supporto Standard

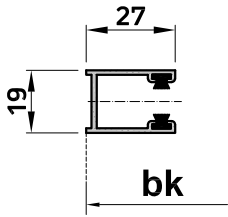

Führungsschiene normal  
Coulisse normale  
Guida normale

NO

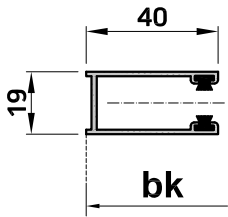

Verstärkte Führung  
Coulisse renforcé  
Guida rinforzata

BR

bk > 3200mm

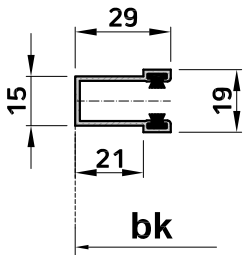

Führungsschiene zum  
Einlassen  
Coulisse à emboîter  
Guida da incasso

EF

hat > 2500 mm

hl

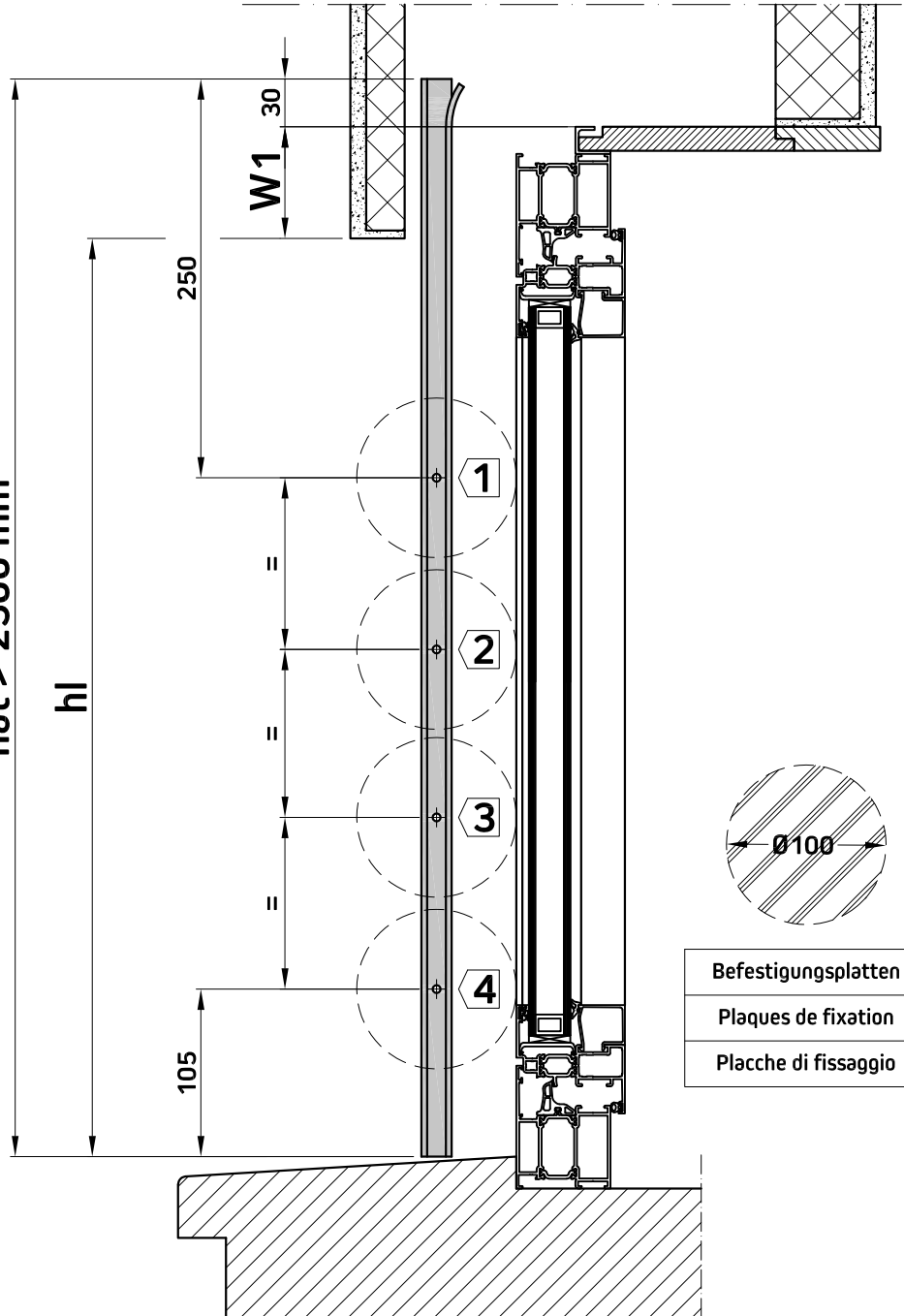

Befestigungslatten

Plaques de fixation

Placche di fissaggio

hat	Führungsschienehöhe (Länge)	Longueur de la coulisse	Lunghezza della guida
hl	Fensterlichhöhe	Hauteur lumière	Altezza luce finestra
w1	Führungsverlängerung	Prolongement de la coulisse	Prolungamento della guida
bk	Breite Konstruktion	Largeur lumière	Larghezza luce finestra

Regaroll®

DOC. CODE: 2DW-200059-V00

Das Komfort Rolladensystem  
Le système de volet roulant confort  
Il sistema di avvolgibile confort

Lochtabelle standard  
Perforation de la coulisse standard  
Foratura guide standard

Technische Daten  
Données techniques  
Dati tecnici

 **Regazzi**

[www.madeinregazzi.ch](http://www.madeinregazzi.ch)

haf < 400 mm  
 \*(mit / avec / with / con W1 standard = 70 mm)

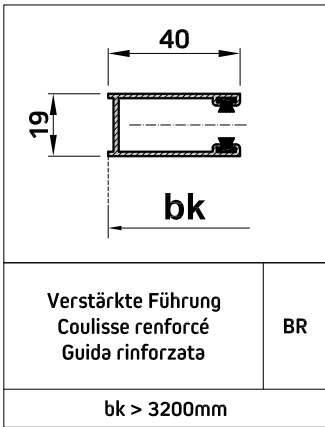
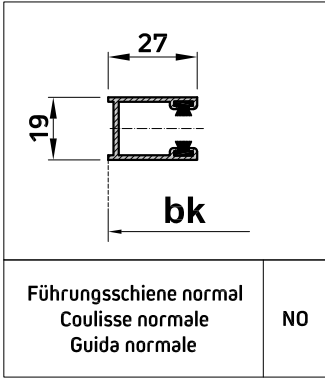

Lager Standard  
 Support standard  
 Supporto Standard

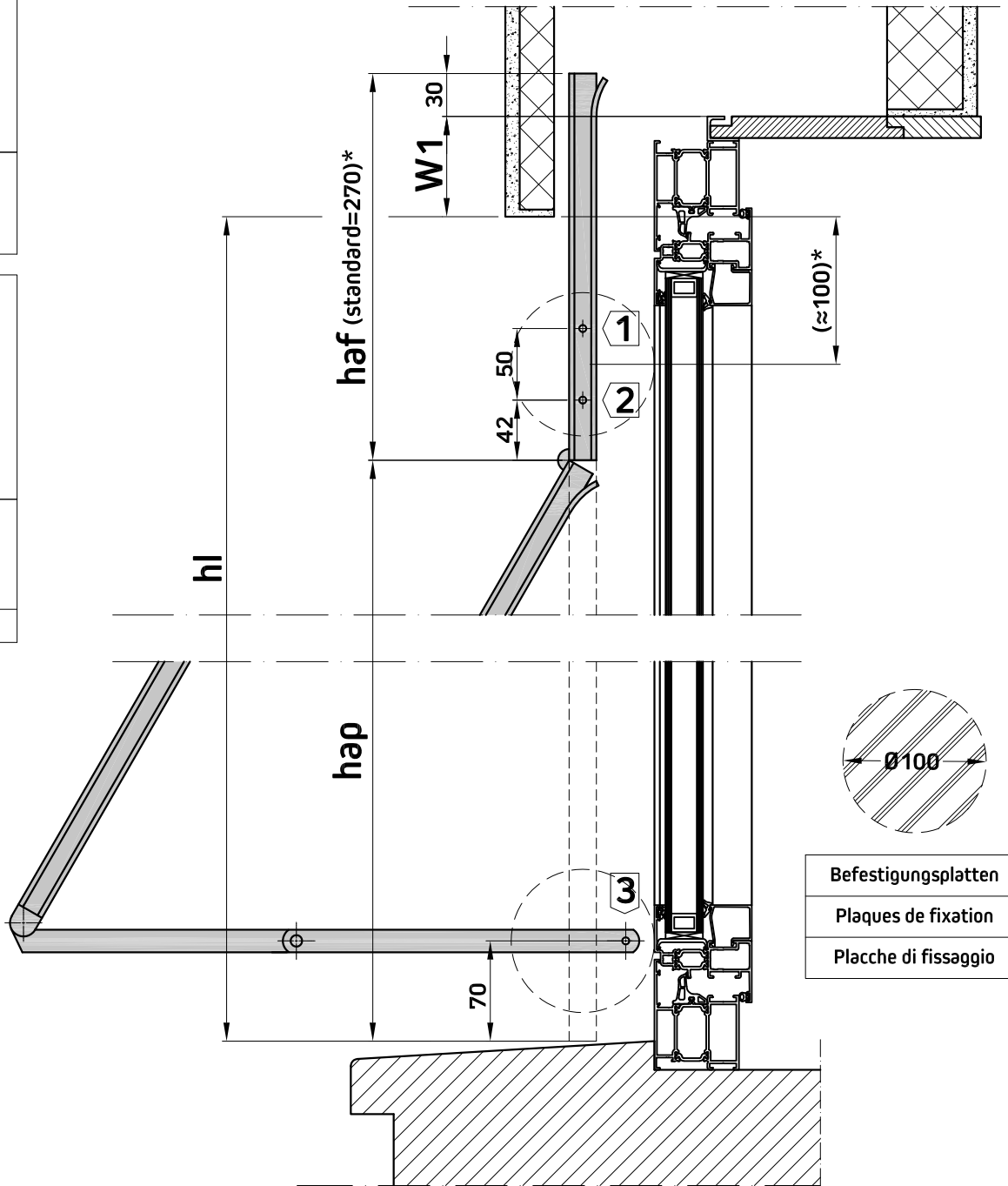

haf	Führungslänge Fester Teil	Longueur de la coulisse fixe	Lunghezza della guida fissa
hap	Führungslänge Beweglicher Teil	Longueur de la coulisse mobile	Lunghezza della guida mobile
hl	Fensterlichhöhe	Hauteur lumière	Altezza luce finestra
w1	Führungsverlängerung	Prolongement de la coulisse	Prolungamento della guida
bk	Breite Konstruktion	Largeur lumière	Larghezza luce finestra

<b>Regaroll®</b>	DOC. CODE: 2DW-200060-V00	Technische Daten Données techniques Dati tecnici	<b>Regazzi</b>
Das Komfort Rolladensystem Le système de volet roulant confort Il sistema di avvolgibile confort	Lochtabelle mit Normal Aussteller und Hebelaussteller Perforation de la coulisse avec projection normale et à levier Foratura guide con spinta normale e a leva		

Proprietà della società Regazzi SA, Gordola. Senza autorizzazione della stessa il presente disegno non potrà essere comunque utilizzato per la costruzione dell'oggetto rappresentato né venire comunicato a terzi o riprodotto. La società proprietaria tutela i propri diritti a rigore di legge.

haf ≥ 400 mm  
 \*(mit / avec / with / con W1 standard = 70 mm)

Lager Standard  
 Support standard  
 Supporto Standard

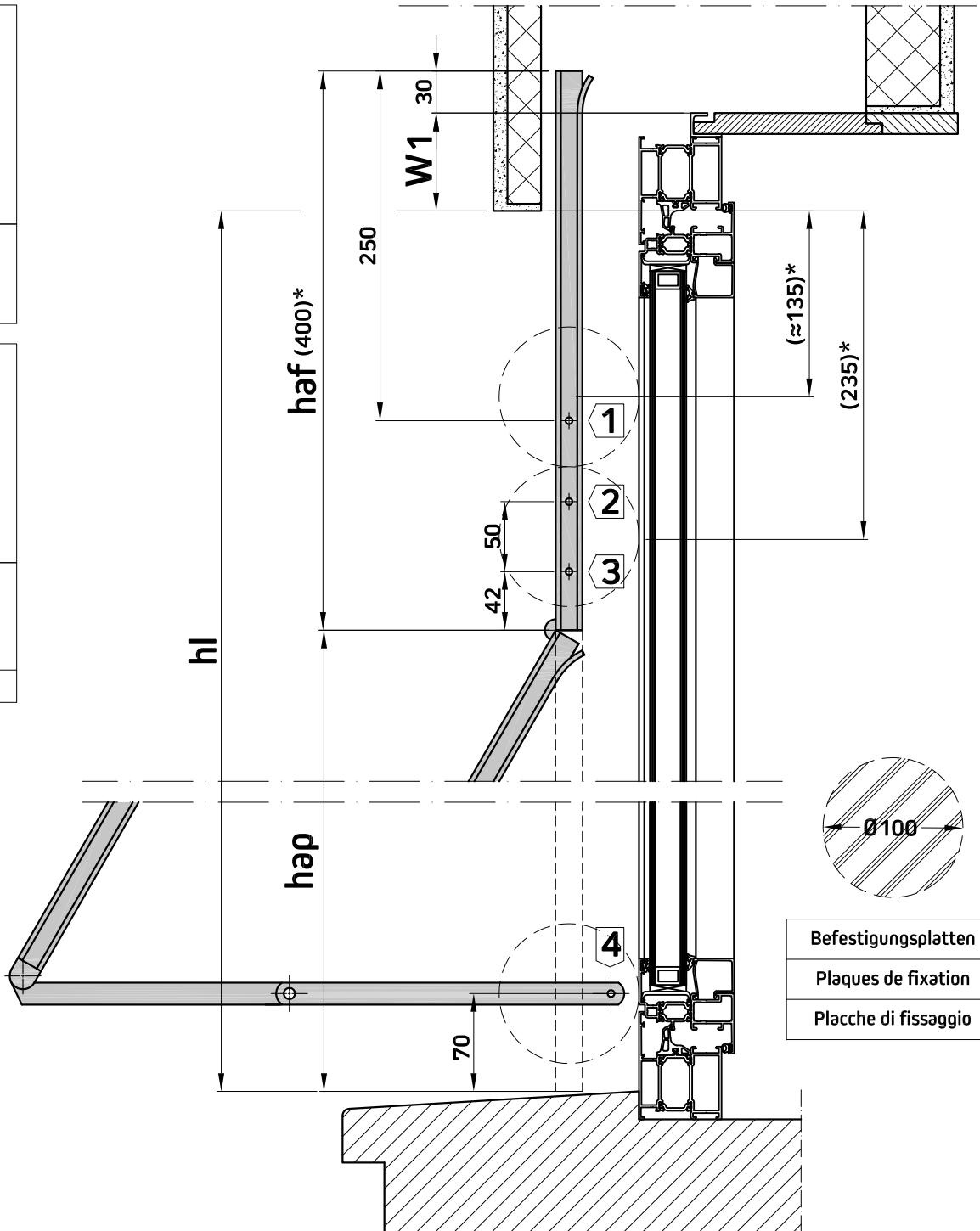
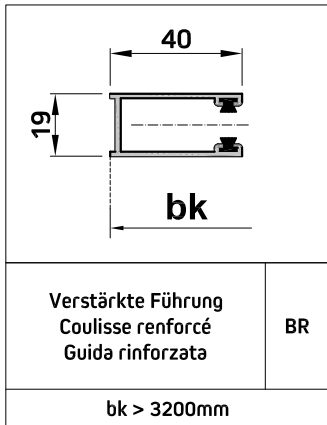
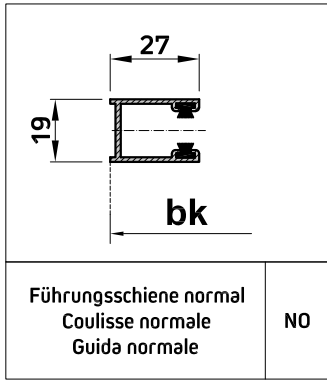

haf	Führungslänge Fester Teil	Longueur de la coulisse fixe	Lunghezza della guida fissa
hap	Führungslänge Beweglicher Teil	Longueur de la coulisse mobile	Lunghezza della guida mobile
hl	Fensterlichhöhe	Hauteur lumière	Altezza luce finestra
w1	Führungsverlängerung	Prolongement de la coulisse	Prolungamento della guida
bk	Breite Konstruktion	Largeur lumière	Larghezza luce finestra

<b>Regaroll®</b>	DOC. CODE: 2DW-200061-V00	Technische Daten Données techniques Dati tecnici	<b>Regazzi</b>
Das Komfort Rolladensystem Le système de volet roulant confort Il sistema di avvolgibile confort	Lochtabelle mit Normal Austeller und Hebelaussteller Perforation de la coulisse avec projection normale et à levier Foratura guide con spinta normale e a leva		

Führungsschienen bis 1500 mm

Longueur de la coulisse jusqu'à 1500mm

Lunghezza della guida fino a 1500 mm

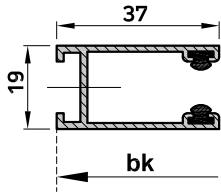

Führungsschiene Regazzi  
Coulisse Regazzi  
Guida Regazzi

Lager QuickRoll® und Quickroll mini  
Support QuickRoll® et QuickRoll® mini  
Supporto QuickRoll® e QuickRoll® mini

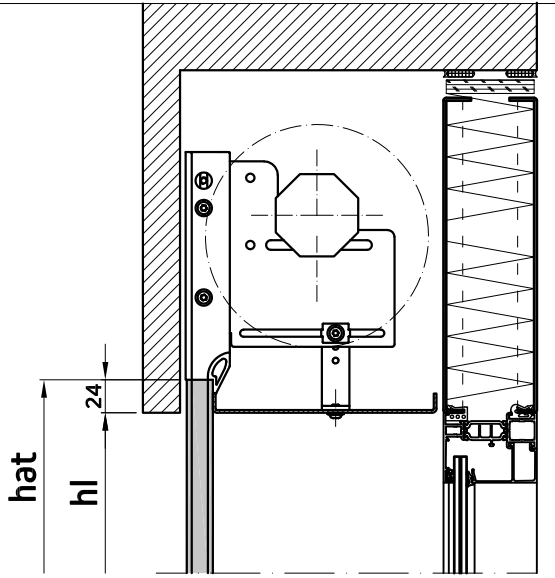

Lager QuickRoll® mit Abdeckung, w1 = 0  
Support QuickRoll® avec plafonnet, w1 = 0  
Supporto QuickRoll® con mantovana, w1 = 0

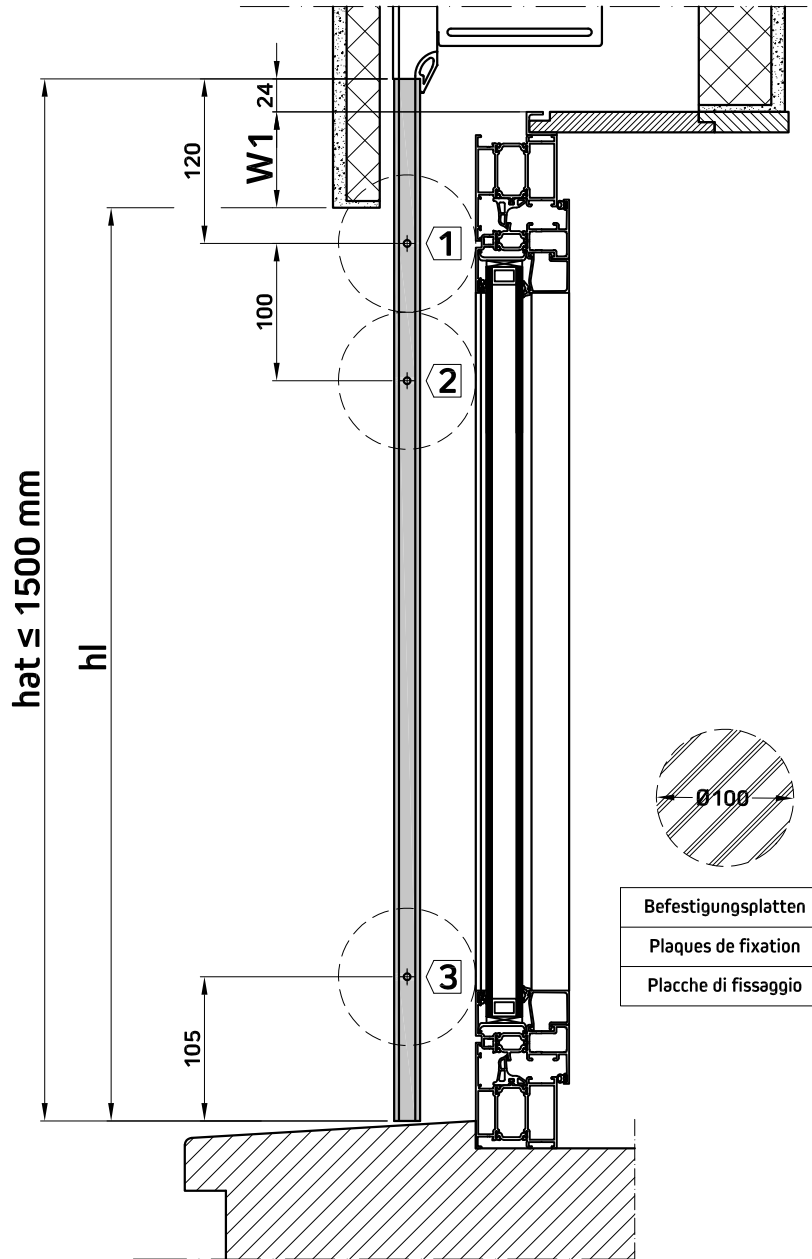

Befestigungsplatten  
Plaques de fixation  
Placche di fissaggio

hat	Führungsschienehöhe (Länge)	Longueur de la coulisse	Lunghezza della guida
hl	Fensterlichhöhe	Hauteur lumière	Altezza luce finestra
w1	Führungsverlängerung	Prolongement de la coulisse	Prolungamento della guida
bk	Breite Konstruktion	Largeur lumière	Larghezza luce finestra

Regaroll®

DOC. CODE: 2DW-200062-V00

Das Komfort Rollladensystem  
Le système de volet roulant confort  
Il sistema di avvolgibile confort

Lochtabelle standard  
Perforation de la coulisse standard  
Foratura guide standard

Technische Daten  
Données techniques  
Dati tecnici

Regazzi

[www.madeinregazzi.ch](http://www.madeinregazzi.ch)

Führungsschienen von 1501 bis 2500 mm

Longueur de la coulisse entre 1501 et 2500 mm

Lunghezza della guida tra 1501 e 2500 mm

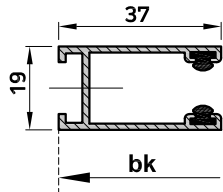

Führungsschiene Regazzi  
Coulisse Regazzi  
Guida Regazzi

Lager QuickRoll® und Quickroll mini  
Support QuickRoll® et QuickRoll® mini  
Supporto QuickRoll® e QuickRoll® mini

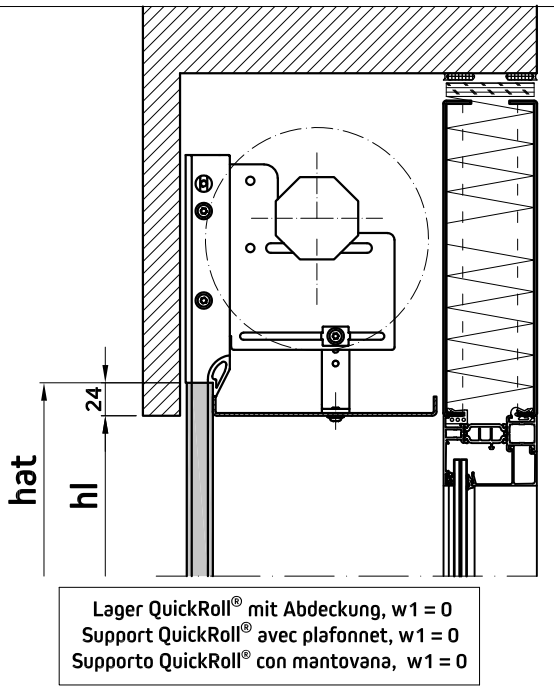

Lager QuickRoll® mit Abdeckung, w1 = 0  
Support QuickRoll® avec plafonnet, w1 = 0  
Supporto QuickRoll® con mantovana, w1 = 0

1501 ≤ hat ≤ 2500 mm

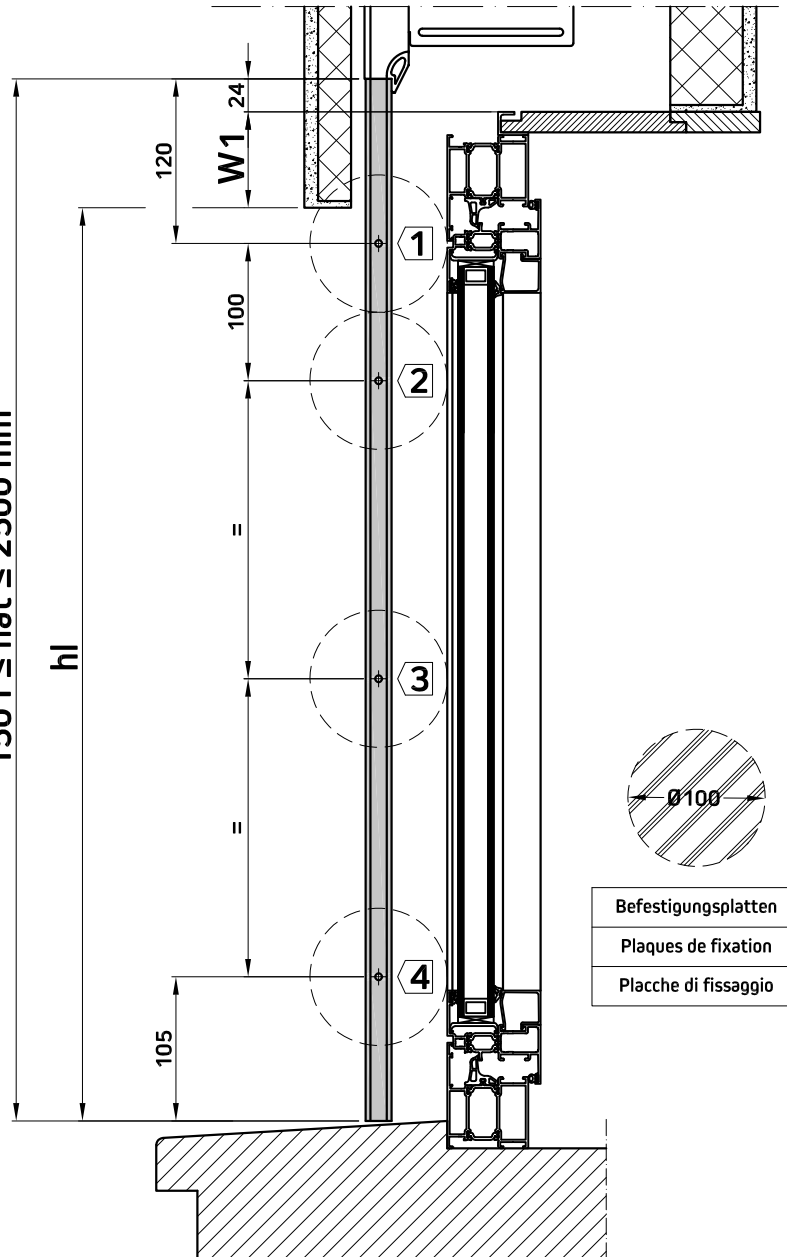

Befestigungsplatten  
Plaques de fixation  
Placche di fissaggio

hat	Führungsschienehöhe (Länge)	Longueur de la coulisse	Lunghezza della guida
hl	Fensterlichhöhe	Hauteur lumière	Altezza luce finestra
w1	Führungsverlängerung	Prolongement de la coulisse	Prolungamento della guida
bk	Breite Konstruktion	Largeur lumière	Larghezza luce finestra

Regaroll®

DOC. CODE: 2DW-200063-V00

Das Komfort Rollladensystem  
Le système de volet roulant confort  
Il sistema di avvolgibile comfort

Lochtabelle standard  
Perforation de la coulisse standard  
Foratura guide standard

Technische Daten  
Données techniques  
Dati tecnici

Regazzi

[www.madeinregazzi.ch](http://www.madeinregazzi.ch)

Führungsschienen über 2500 mm
Longueur de la coulisse supérieur à 2500mm
Lunghezza della guida superiore a 2500 mm

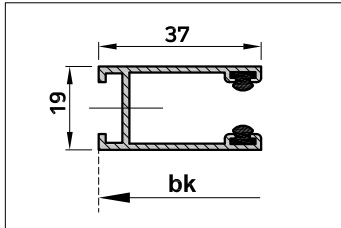

Führungsschiene Regazzi  
Coulisse Regazzi  
Guida Regazzi

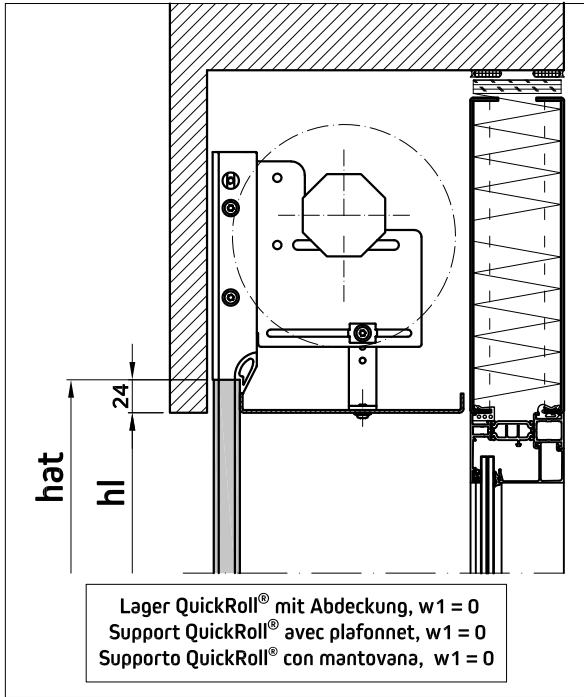

Lager QuickRoll® mit Abdeckung, w1 = 0  
Support QuickRoll® avec plafonnet, w1 = 0  
Supporto QuickRoll® con mantovana, w1 = 0

Lager QuickRoll®  
Support QuickRoll®  
Supporto QuickRoll®

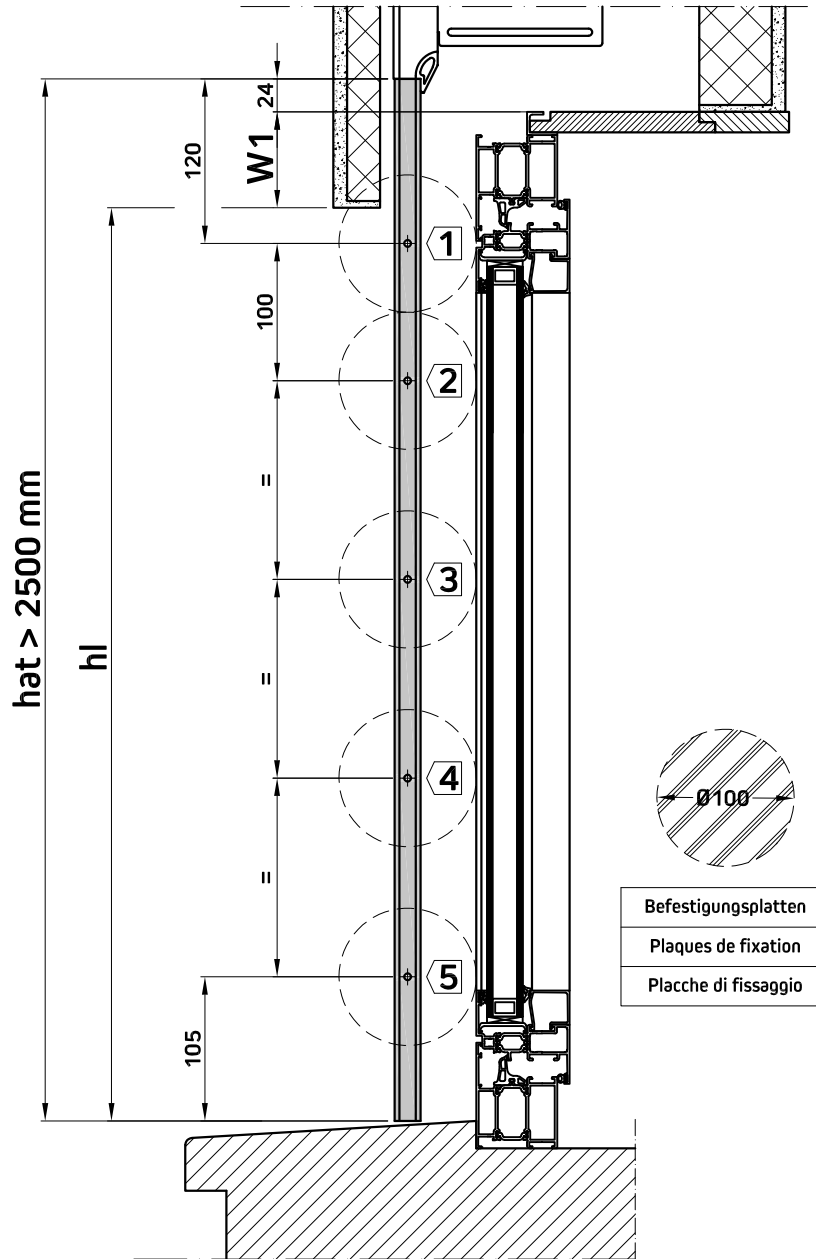

hat	Führungsschienenhöhe (Länge)	Longueur de la coulisse	Lunghezza della guida
hl	Fensterlichhöhe	Hauteur lumière	Altezza luce finestra
w1	Führungsverlängerung	Prolongement de la coulisse	Prolungamento della guida
bk	Breite Konstruktion	Largeur lumière	Larghezza luce finestra

<b>Regaroll®</b>  Das Komfort Rollladensystem Le système de volet roulant confort Il sistema di avvolgibile confort	DOC. CODE: 2DW-200064-V00	Technische Daten Données techniques Dati tecnici	  <a href="http://www.madeinregazzi.ch">www.madeinregazzi.ch</a>
	Lochtabelle standard Perforation de la coulisse standard Foratura guide standard		



haf < 400 mm  
 \*(mit / avec / with / con W1 standard = 70 mm)

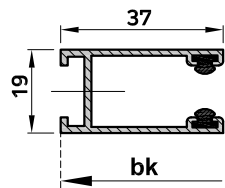

Führungsschiene Regazzi  
 Coulisse Regazzi  
 Guida Regazzi

Achtung: Diese speziellen Bohrungen als zusätzliche Befestigungspunkte nutzen!

Attention : utiliser les trous du support comme fixation supplémentaire

Attenzione: utilizzare i fori sul supporto come fissaggio aggiuntivo

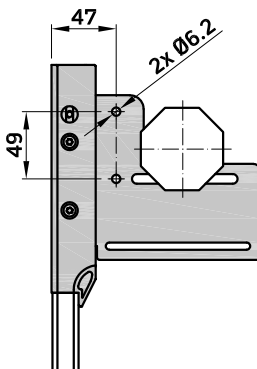

Lager QuickRoll® und Quickroll mini  
 Support QuickRoll® et QuickRoll® mini  
 Supporto QuickRoll® e QuickRoll® mini

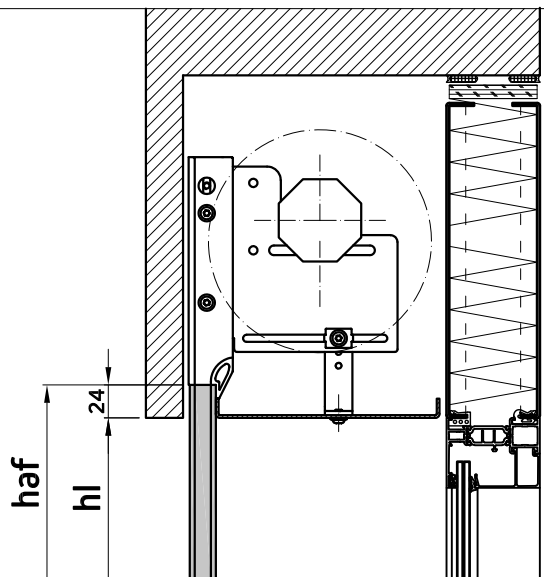

Lager QuickRoll® mit Abdeckung, w1 = 0  
 Support QuickRoll® avec plafonnet, w1 = 0  
 Supporto QuickRoll® con mantovana, w1 = 0

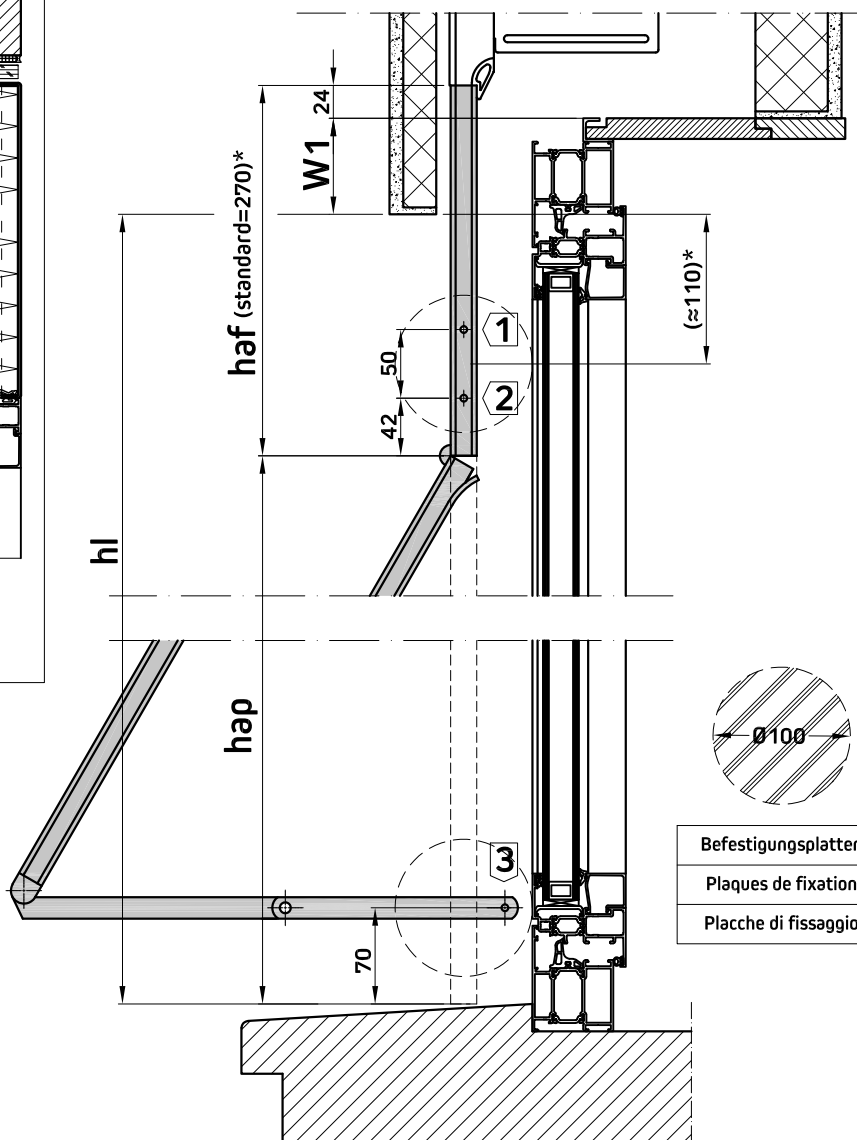

Befestigungsplatten  
 Plaques de fixation  
 Placche di fissaggio

haf	Führungslänge Fester Teil	Longueur de la coulisse fixe	Lunghezza della guida fissa
hap	Führungslänge Beweglicher Teil	Longueur de la coulisse mobile	Lunghezza della guida mobile
hl	Fensterlichhöhe	Hauteur lumière	Altezza luce finestra
w1	Führungsverlängerung	Prolongement de la coulisse	Prolungamento della guida
bk	Breite Konstruktion	Largeur lumière	Larghezza luce finestra

Regaroll®

DOC. CODE: 2DW-200065-V00

Das Komfort Rollladensystem  
 Le système de volet roulant confort  
 Il sistema di avvolgibile confort

Lochtabelle mit Normal Aussteller und Hebelaussteller  
 Perforation de la coulisse avec projection normale et à levier  
 Foratura guide con spinta normale e a leva

Technische Daten  
 Données techniques  
 Dati tecnici

Regazzi

www.madeinregazzi.ch

haf ≥ 400 mm  
 \*(mit / avec / with / con W1 standard = 70 mm)

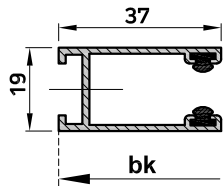

Führungsschiene Regazzi  
 Coulisse Regazzi  
 Guida Regazzi

Achtung: Diese speziellen Bohrungen als zusätzliche Befestigungspunkte nutzen!

Attention : utiliser les trous du support comme fixation supplémentaire

Attenzione: utilizzare i fori sul supporto come fissaggio aggiuntivo

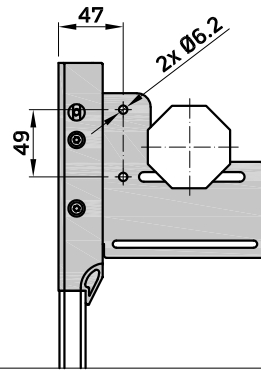

Lager QuickRoll® und Quickroll mini  
 Support QuickRoll® et QuickRoll® mini  
 Supporto QuickRoll® e QuickRoll® mini

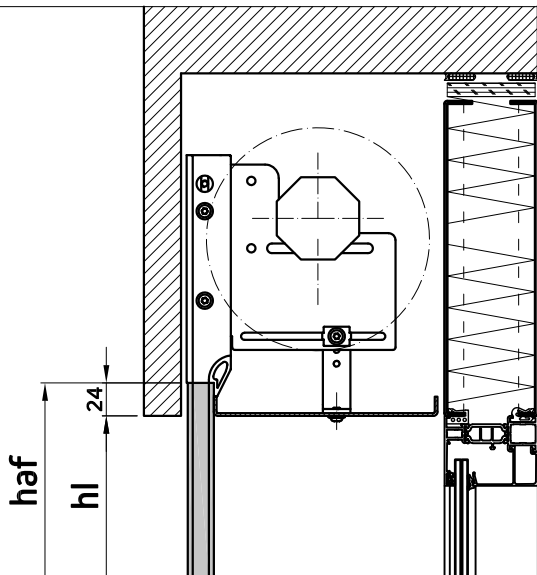

Lager QuickRoll® mit Abdeckung, w1 = 0  
 Support QuickRoll® avec plafonnet, w1 = 0  
 Supporto QuickRoll® con mantovana, w1 = 0

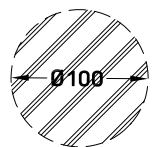
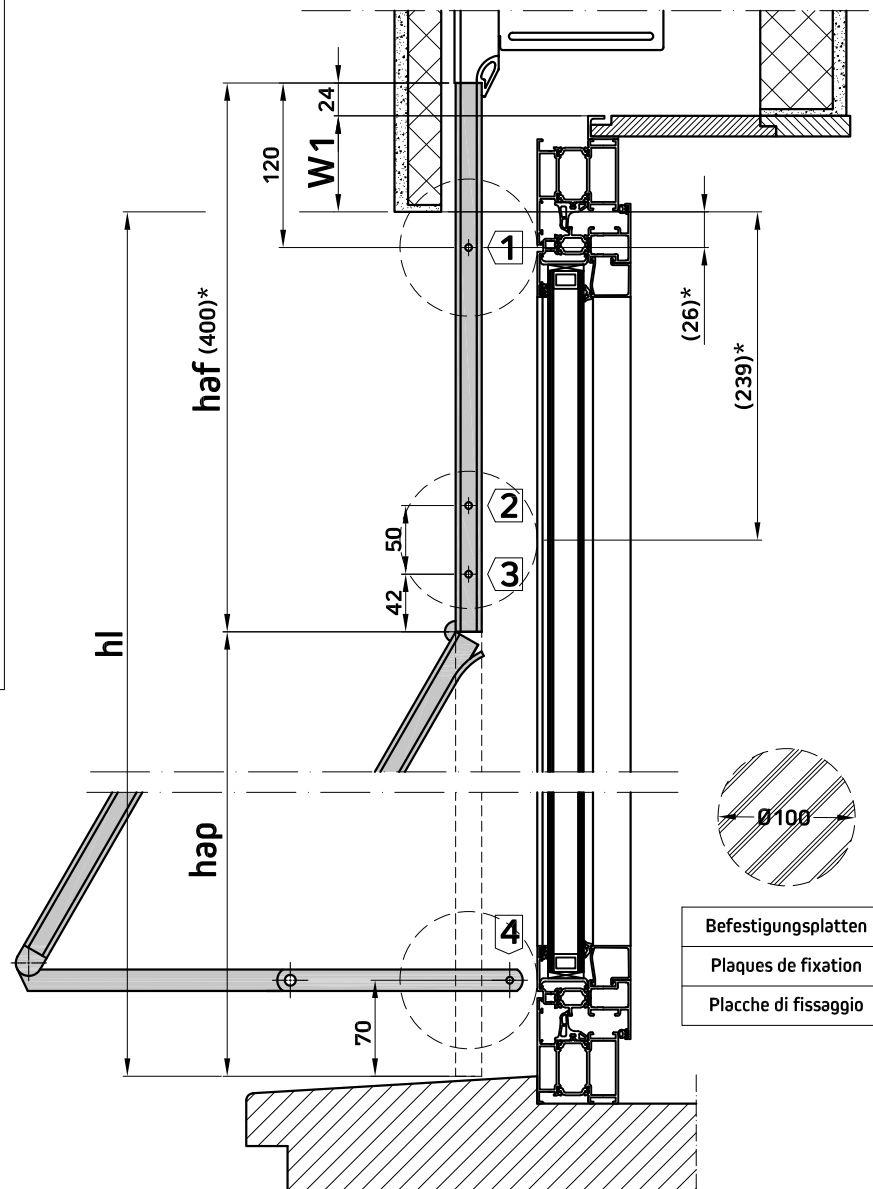

Befestigungsplatten  
 Plaques de fixation  
 Placche di fissaggio

haf	Führungslänge Fester Teil	Longueur de la coulisse fixe	Lunghezza della guida fissa
hap	Führungslänge Beweglicher Teil	Longueur de la coulisse mobile	Lunghezza della guida mobile
hl	Fensterlichhöhe	Hauteur lumière	Altezza luce finestra
w1	Führungsverlängerung	Prolongement de la coulisse	Prolungamento della guida
bk	Breite Konstruktion	Largeur lumière	Larghezza luce finestra

Regaroll®

DOC. CODE: 2DW-200066-V00

Das Komfort Rollladensystem  
 Le système de volet roulant confort  
 Il sistema di avvolgibile confort

Lochtabelle mit Normal Aussteller und Hebelaussteller  
 Perforation de la coulisse avec projection normale et à levier  
 Foratura guide con spinta normale e a leva

Technische Daten  
 Données techniques  
 Dati tecnici

Regazzi

www.madeinregazzi.ch

## Lochtabelle standard - Perforation coulisses standard - Foratura standard

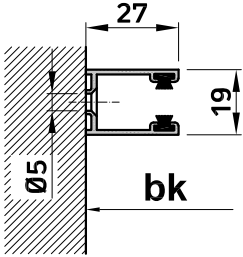
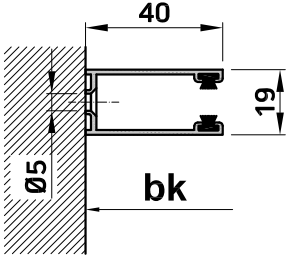
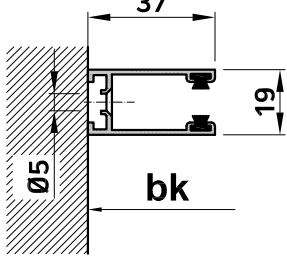
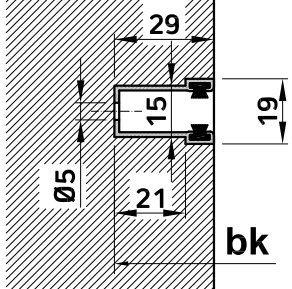
						
Führungsschiene normal Coulisse normale Guida normale	NO	Verstärkte Führung Coulisse renforcé Guida rinforzata	BR	Führungsschiene Regazzi Coulisse Regazzi Guida Regazzi	Führungsschiene zum Einlassen Coulisse à emboîter Guida da incasso	EF

## Lochtabelle frontal - Perforation coulisses Façade - Foratura frontale

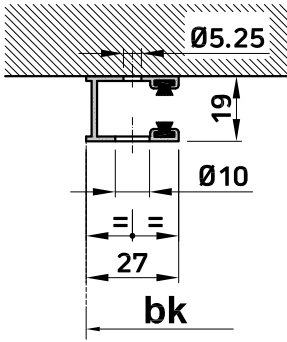
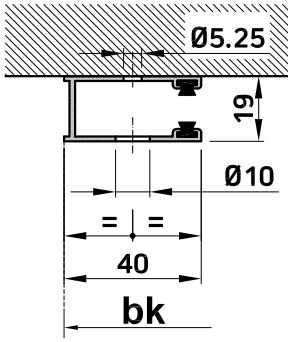
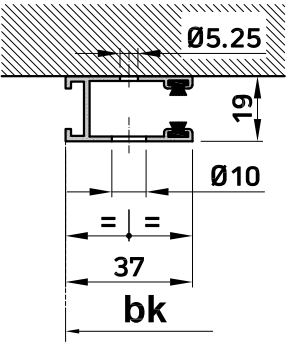
				
Führungsschiene normal Coulisse normale Guida normale	NO	Verstärkte Führung Coulisse renforcé Guida rinforzata	BR	Führungsschiene Regazzi Coulisse Regazzi Guida Regazzi

bk	Breite Konstruktion	Largeur lumière	Larghezza luce finestra
----	---------------------	-----------------	-------------------------

<b>Regaroll®</b>	DOC. CODE: 2DW-200091-V00	Technische Daten Données techniques Dati tecnici	 <b>Regazzi</b> <a href="http://www.madeinregazzi.ch">www.madeinregazzi.ch</a>
Das Komfort Rolladensystem Le système de volet roulant confort Il sistema di avvolgibile confort	Lochtabelle Perforation de la coulisse Foratura guide		