

POS	IHRE REF. / KOM. VOTRE RÉF. / COM RIF. / COM

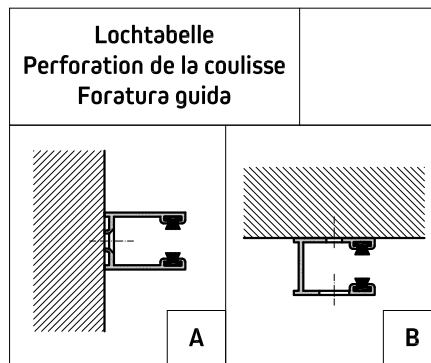

Führungsschiene Typ Typologie coulisse Tipologie guide	
--	--

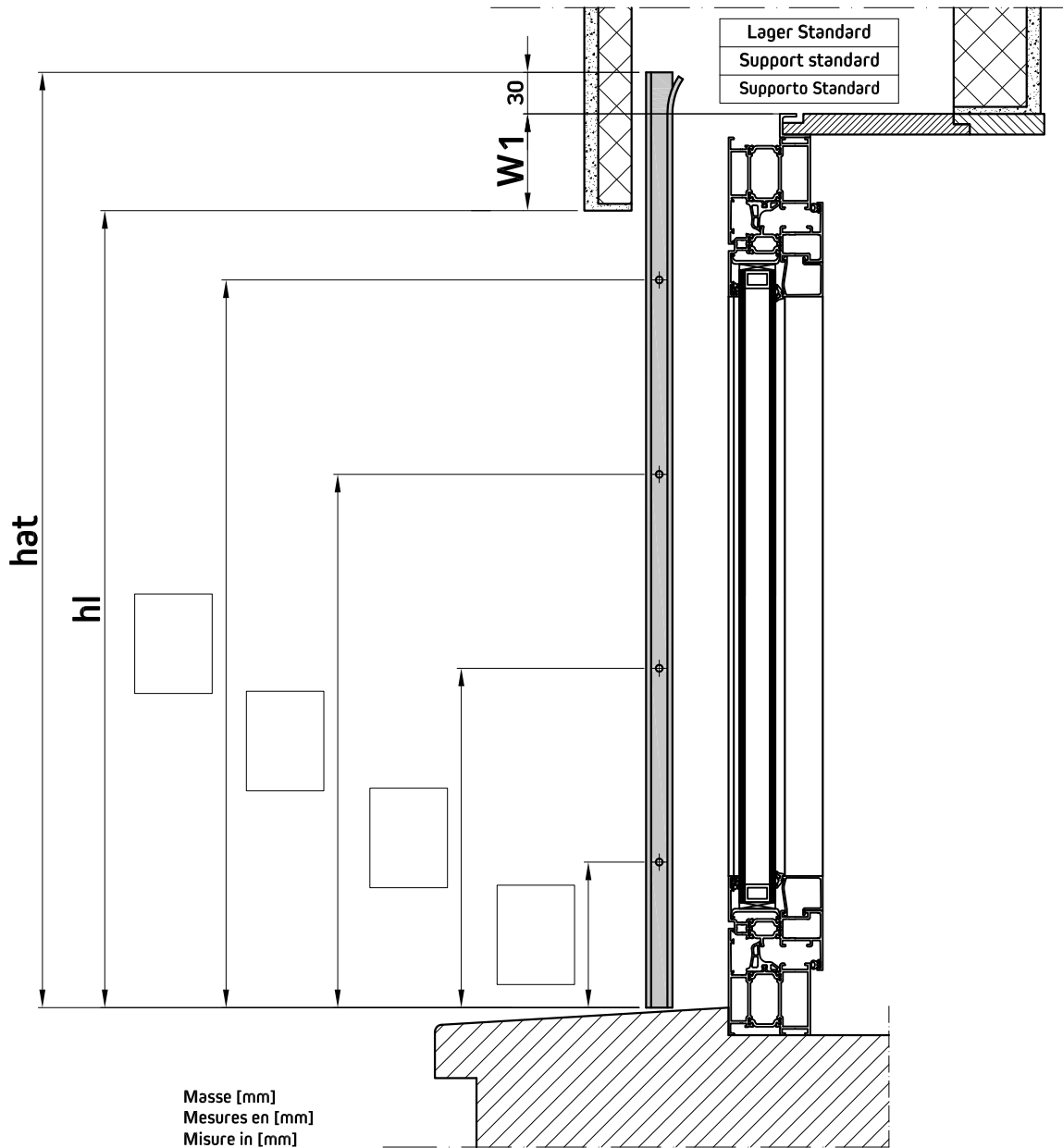
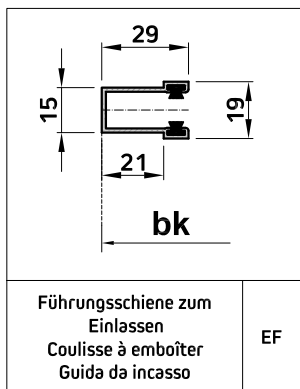
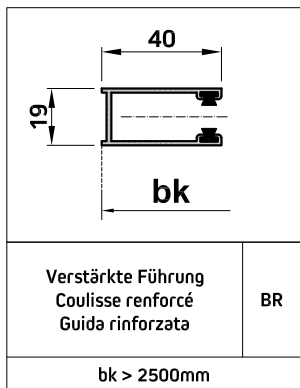
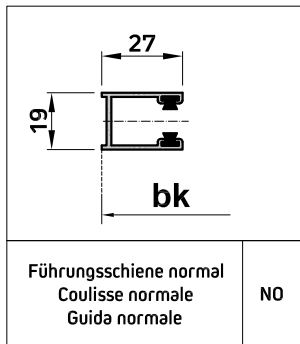

hat	Führungsschienehöhe (Länge)	Longueur de la coulisse	Lunghezza della guida
hl	Fensterlichthöhe	Hauteur lumière	Altezza luce finestra
w1	Führungsverlängerung	Prolongement de la coulisse	Prolungamento della guida
bk	Breite Konstruktion	Largeur lumière	Larghezza luce finestra

Regacompact®

DOC. CODE: 2DW-200081-V00

Rolladen mit beweglichen Stäben  
Volet à rouleau à lames mobiles  
Avvolgibile a stecche mobili infilate

Lochtabelle Sondermasse  
Perforation de la coulisse sur dessin  
Foratura guida a disegno

Anhang zum Bestellformular  
À joindre au formulaire de  
commande  
Da allegare al formulario  
d'ordine

 **Regazzi**

[www.madeinregazzi.ch](http://www.madeinregazzi.ch)

POS	IHRE REF. / KOM. VOTRE RÉF. / COM RIF. / COM

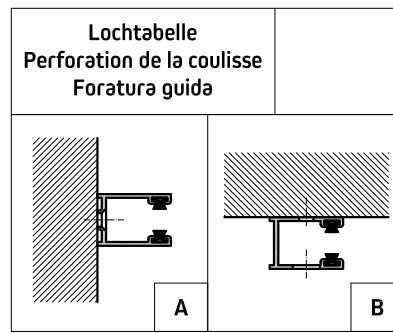

Führungsschiene Typ Typologie coulisse Tipologie guide	
--	--

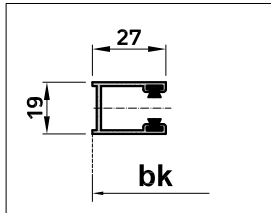

Führungsschiene normal Coulisse normale Guida normale	NO
---	----

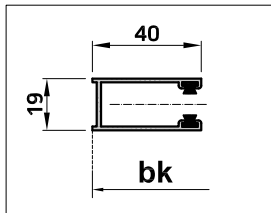

Verstärkte Führung Coulisse renforcé Guida rinforzata	BR
bk > 2500mm	

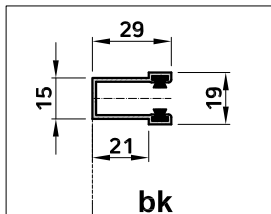

Führungsschiene zum Einlassen Coulisse à emboîter Guida da incasso	EF
--	----

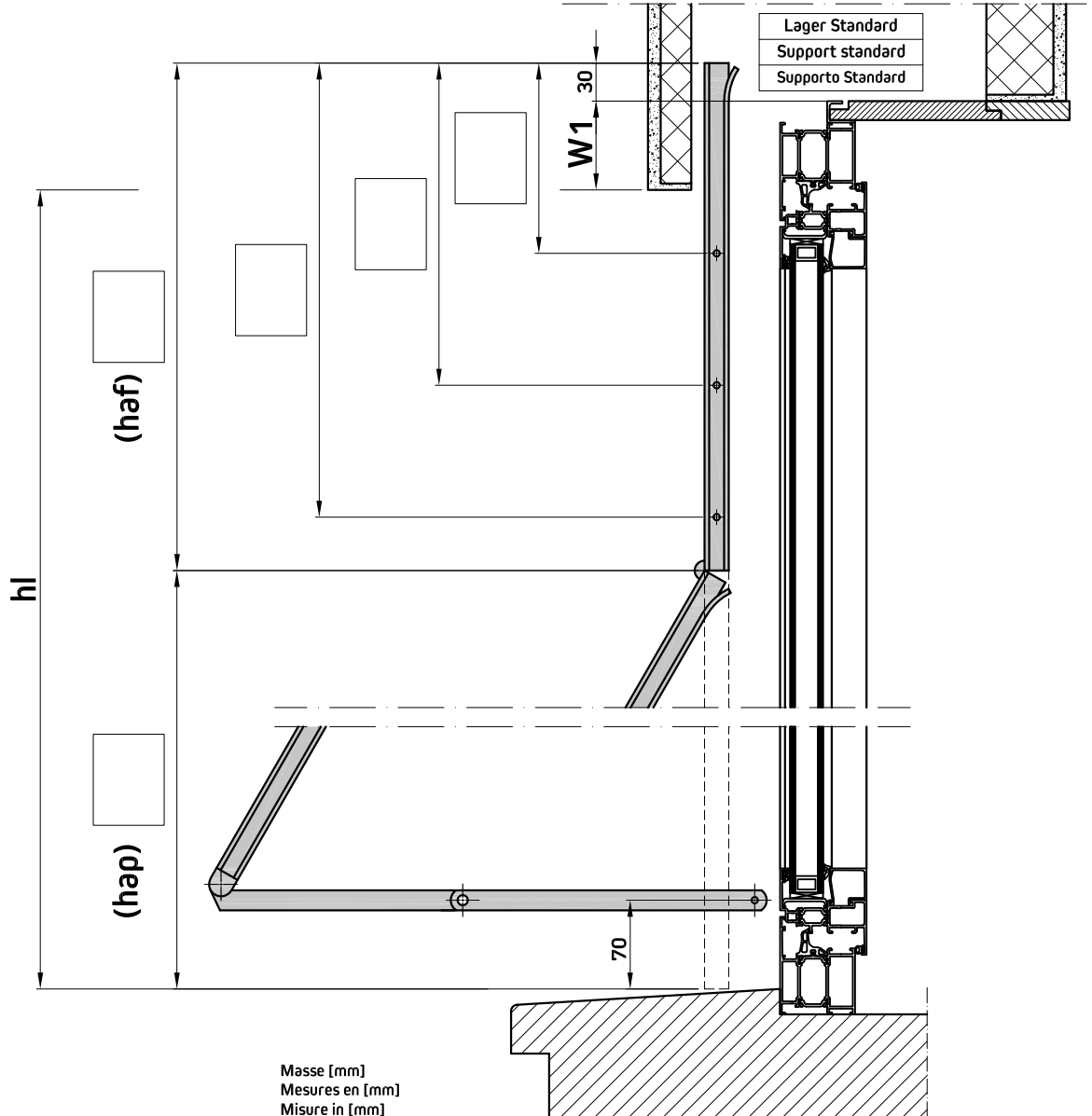

Masse [mm]  
Mesures en [mm]  
Misure in [mm]

haf	Führungslänge Fester Teil	Longueur de la coulisse fixe	Lunghezza della guida fissa
hap	Führungslänge Beweglicher Teil	Longueur de la coulisse mobile	Lunghezza della guida mobile
hl	Fensterlichhöhe	Hauteur lumière	Altezza luce finestra
w1	Führungsverlängerung	Prolongement de la coulisse	Prolungamento della guida
bk	Breite Konstruktion	Largeur lumière	Larghezza luce finestra

<b>Regacompact®</b>  Rolladen mit beweglichen Stäben Volet à rouleau à lames mobiles Avvolgibile a stecche mobili infilate	DOC. CODE: 2DW-200082-V00	Anhang zum Bestellformular À joindre au formulaire de commande Da allegare al formulario d'ordine	  <a href="http://www.madeinregazzi.ch">www.madeinregazzi.ch</a>
	Lochtablelle Sondermasse Perforation de la coulisse sur dessin Foratura guide a disegno		

POS	IHRE REF. / KOM. VOTRE RÉF. / COM RIF. / COM

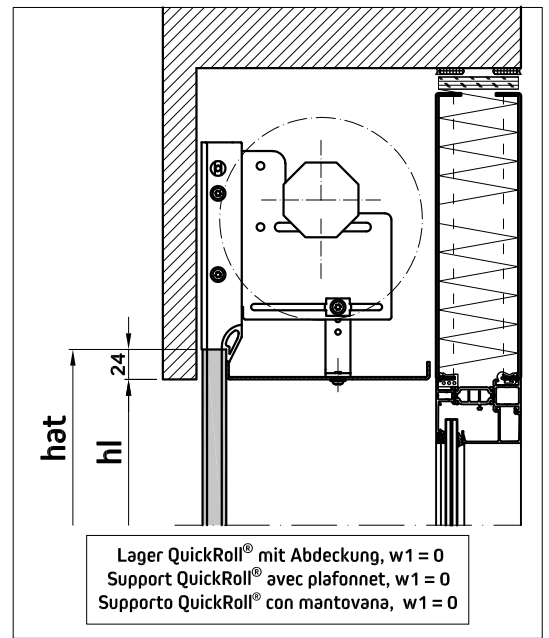
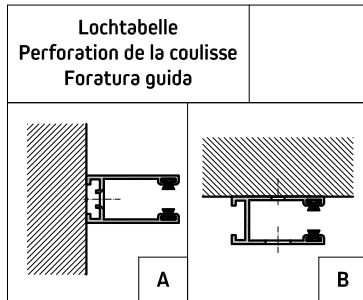
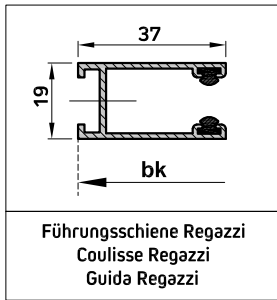

Lager QuickRoll® und Quickroll mini  
Support QuickRoll® et QuickRoll® mini  
Supporto QuickRoll® e QuickRoll® mini

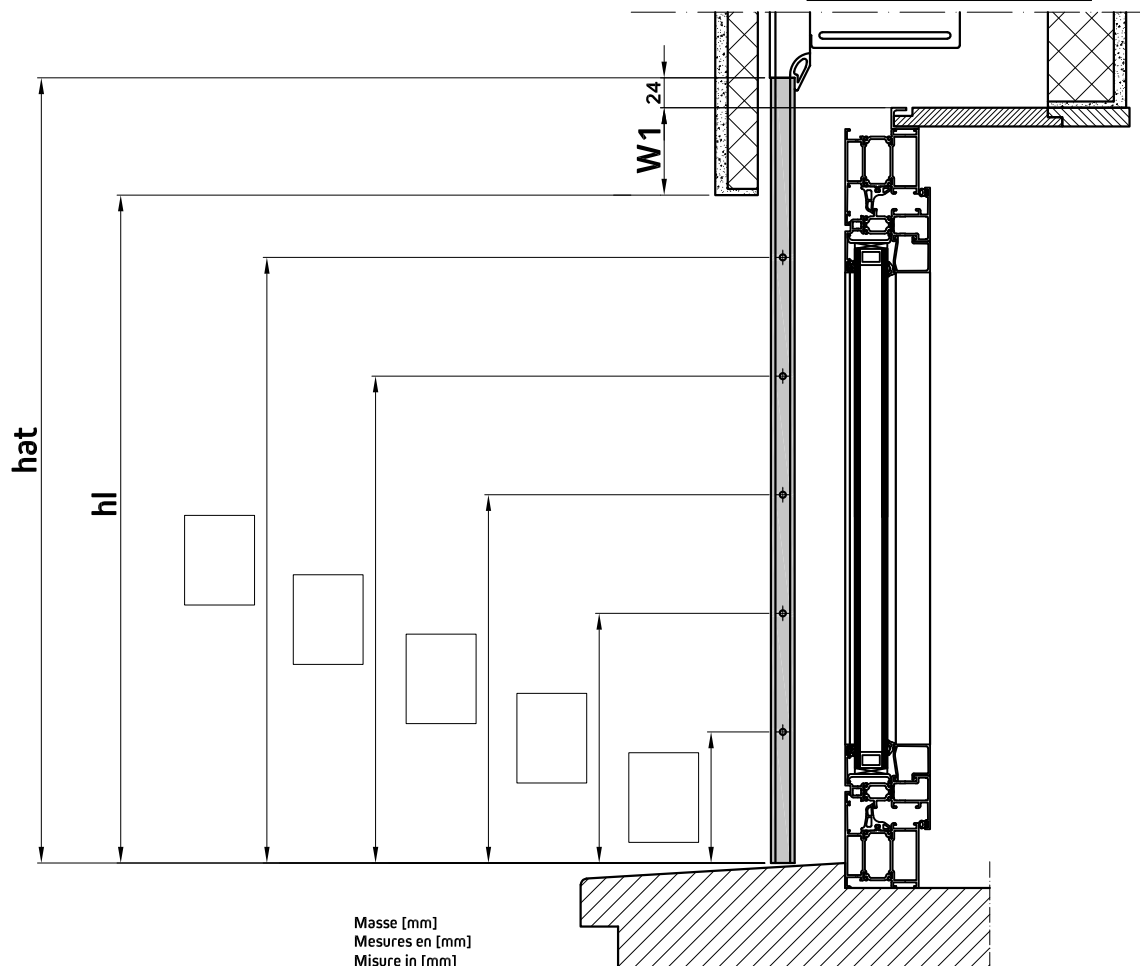

hat	Führungsschienehöhe (Länge)	Longueur de la coulisse	Lunghezza della guida
hl	Fensterlichthöhe	Hauteur lumière	Altezza luce finestra
w1	Führungsverlängerung	Prolongement de la coulisse	Prolungamento della guida
bk	Breite Konstruktion	Largeur lumière	Larghezza luce finestra

<b>Regacompact®</b>	DOC. CODE: 2DW-200083-V00	Anhang zum Bestellformular À joindre au formulaire de commande Da allegare al formulario d'ordine	 <b>Regazzi</b>
Rolläden mit beweglichen Stäben Volet à rouleau à lames mobiles Avvolgibile a stecche mobili infilate	Lochtabelle Sondermasse Perforation de la coulisse sur dessin Foratura guida a disegno		

POS	IHRE REF. / KOM. VOTRE RÉF. / COM RIF. / COM

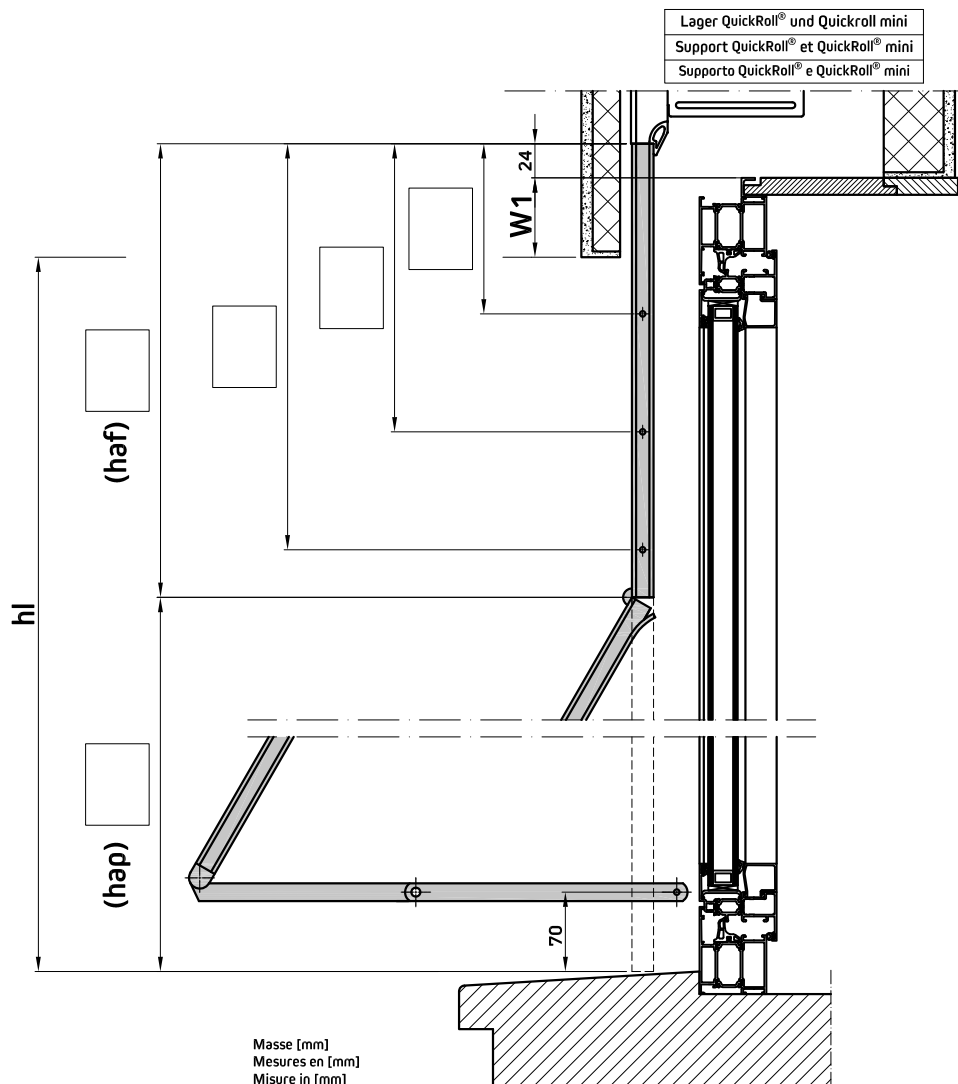
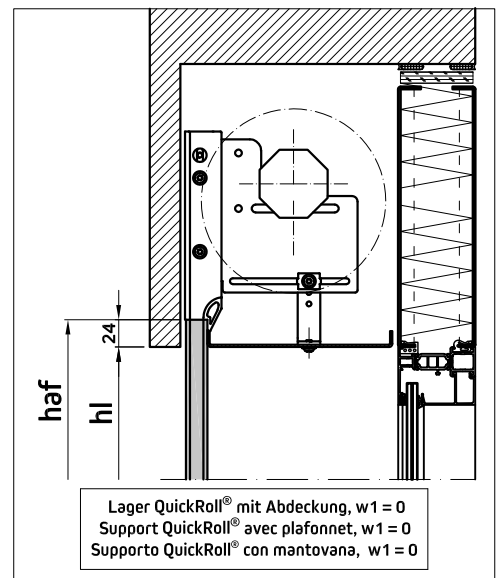
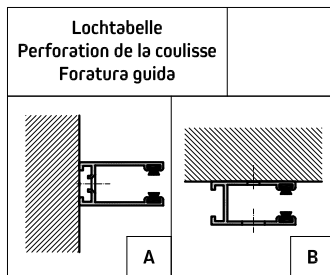
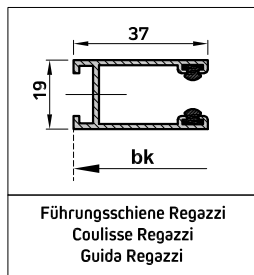

haf	Führungslänge Fester Teil	Longueur de la coulisse fixe	Lunghezza della guida fissa
hap	Führungslänge Beweglicher Teil	Longueur de la coulisse mobile	Lunghezza della guida mobile
hl	Fensterlichthöhe	Hauteur lumière	Altezza luce finestra
w1	Führungsverlängerung	Prolongement de la coulisse	Prolungamento della guida
bk	Breite Konstruktion	Largeur lumière	Larghezza luce finestra

**Regacompat®**

DOC. CODE: 2DW-200084-V00

Rolladen mit beweglichen Stäben  
Volet à rouleau à lames mobiles  
Avvolgibile a stecche mobili infilate

Lochtabelle Sondermasse  
Perforation de la coulisse sur dessin  
Foratura guide a disegno

Anhang zum Bestellformular  
À joindre au formulaire de  
commande  
Da allegare al formulario  
d'ordine

**Regazzi**

[www.madeinregazzi.ch](http://www.madeinregazzi.ch)